



TURBIDITY BARRIER INSTALLATION GUIDE

This guide is designed to provide standard procedures for using Turbidity Barriers a sediment control barriers designed to prevent the spread of silt and sediment from construction sites into downstream or connecting waterways.

CONTENT

1	INTRODUCTION	3
2	TECHNICAL NOTE: INSTALLATION	3
3	TURBIDITY BARRIER WORKSHEET	4
4	ANCHOR KIT INSTALLATION	4
5	DISCLAIMER	5

1. INTRODUCTION

Turbidity Barriers are constructed from impermeable materials, Layfield turbidity barriers are suspended within a body of water, supported by a floatation material within the top edge, and held vertically by a ballast within the bottom edge. These barriers are used in different applications to keep work areas completely contained.

2. TECHNICAL NOTE: INSTALLATION

1. Prepare your staging area as close as possible to the installation site. This staging area must be debris-free, which could damage the barrier curtain.

2. Determine the endpoints of the barrier line and install anchors. The EPA & DFO (Canada) do NOT approve the use of trees for barrier anchors. Install the anchors. These may be steel or wood posts, concrete dead men or some existing structure to which the Barrier can be connected. Anchors must be in place before the curtain is deployed.

3. Unroll the Barrier section and spread it out. If the installed Barrier is longer than 100', more than one section will be required. Unroll the second section and spread it out with the joining vertical edges next to each other.

4. Join the two edges of the connection sections with rope or heavy-duty plastic wire ties through the grommets in the barrier edges. Make sure the curtains are always oriented the same way so that the load cables connect the hook to the thimble.

5. It will be advantageous to FURL the curtain sections by passing lines around the skirt of the curtain and the flotation and pulling the skirt tightly up against the flotation section. These lines should be placed at the center of each flotation block. Any synthetic rope of 1/4" in diameter or larger will be adequate for these furling lines. (if these lines are to be used to re-furl the curtain for removal from the water, they must be at least twice the curtain depth plus 6' so they can be left in place when the Barrier is unfurled).

6. A portion of the first curtain can now be floated into the water. Carefully slide the curtain into the water and secure the leading end to the workboat. The boat should be rigged with a long line attached to the load cable of the first curtain so that the curtain can be positioned without interfering with the boat's ability to maneuver.

7. Unfold the next Barrier in the sequence and repeat the procedure, connecting the edges, bundling, tying and extending the furled portion into the water. Make sure the correct sequence is followed so that the proper depth Barrier occurs at the predicted position in the barrier line. The workboat will control the Barriers as they are assembled and extended along the pre-positioned anchor line.

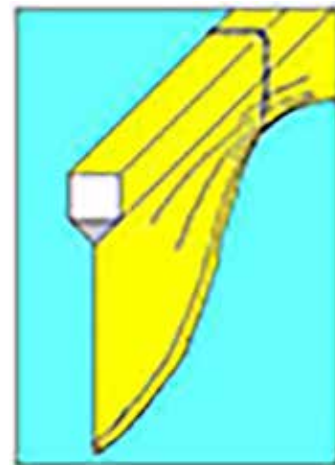

Image 1. Diagram of Furling

8. Connect the leading end of the Barrier to its anchor point by passing a line through at least three of the end grommets and then to the anchor point. Connect the other end of the Barrier to its anchor point similarly.

9. When the Barrier is in its desired position, the FURLING lines can be loosened to lower the skirt to its proper depth.

10. It may be necessary to attach intermediate anchors to the Barrier to keep it from drifting into the work area. Concrete blocks, boat anchors or other devices sufficient to hold the Barrier in place may be used (Layfield does supply complete anchor kits).

11. Anchors need to be placed at strategic locations and should be attached only to the Barrier at the vertical joint. They should not be required to carry any significant load. The anchor line should be supported by a buoy to prevent any direct pull on the anchor itself (included in Layfield's anchor kit).

12. Always follow the installation guide attached to every barrier section.

13. Maintenance: Periodic inspections of the Barrier should be made, particularly following storm events, to ensure the barrier and anchor connections are secure. Debris should be cleared away from the Barrier flotation section. In addition, since this design calls for the Barrier to rest on the lake bottom, the Barrier could accumulate silt and cause it to sink below the water surface. Although unlikely to happen, there is a possibility it could occur over an extended time.

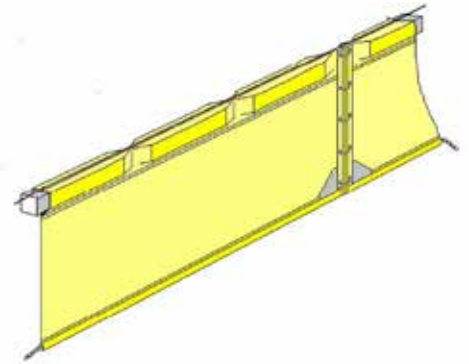

Image 2. Drawing of Turbidity Baffle

3. TURBIDITY BARRIER WORKSHEET

The standard practice in installing barriers is to keep the lower edge of the barrier about 12 inches above the bottom as shown in Figure 1. When the lower edge of the barrier is long enough to drape on the bottom, silt will build up as shown in Figure 2. If the build-up is allowed to collect over a long period of time, the barrier may be pulled beneath the surface of the water. The build-up also makes it difficult to remove the barrier without stirring up the silt and sending it back in to the water course.

The placement of turbidity barriers directly across streams having currents greater than 1 foot per second is never recommended. Cross currents as shown in Figure 3 place extreme loads on the barrier system. The bottom of the skirt must be kept above the stream bottom as shown in Figure 1 so that the barrier does not become an impediment to the stream flow. The determination of anchor and cable loads is critical in this application and must be carefully considered before any installation is attempted. However, short skirts can be placed across slow currents to collect loose debris, but cannot be effective for collecting sediment and silt.

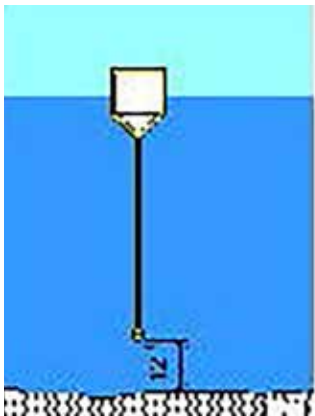

Figure 1. Lower edge about 12 inches above ground.

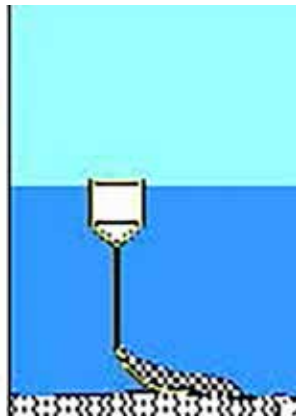

Figure 2. Lower edge drape the bottom building up silt.



Figure 3. Lower edge about 12 inches above ground.

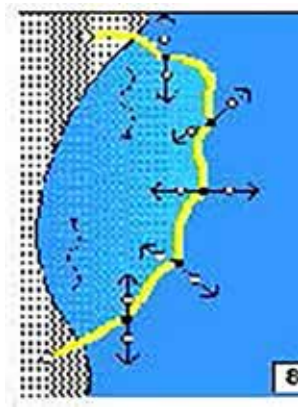

Figure 4. Typical barrier system in a tidal environment

Figure 4 shows a typical barrier system in a tidal environment. The anchoring arrangement is as shown in Figure 3. Type II barriers are required and lighted buoys may be necessary when boating activities are nearby.

Figure 5 shows a barrier placed around a submerged construction site such as a bridge pier or caisson. Anchors may be necessary on both sides of the barriers to keep it in line. Some method for separating the curtain to allow ingress and egress will also be needed.

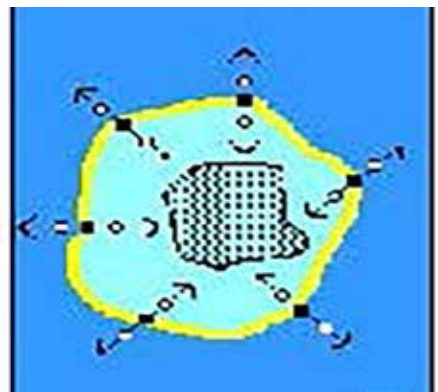

Figure 5. Barrier placed around a submerged construction site

4. ANCHOR KIT INSTALLATION

SYSTEM DESCRIPTION: Type 2 and Type 3 Floating Turbidity Barriers must be anchored to maintain their position in water currents, wind, and/or tidal movements. To protect the barrier, the anchoring system must be engineered to handle the stress load that moving water imparts on the barrier. Following are guidelines for the proper specifications and installation of an Anchor Kit. Anchor Kits are engineered to best position and protect Types 2 and 3 Turbidity Barriers. Each component fulfills a

specific function, as described herein, and all components are factory assembled – ready to be simply attached to the floating barrier.

- The ANCHOR BUOY is necessary to act as a buffer between the anchor and the barrier. It protects the barrier from sudden, damaging stress from the anchor line due to wave, current, or wind actions. Each order includes an air needle to allow easy buoy inflation.
- The POSITIONING/RETRIEVAL BUOY is necessary to allow easy installation, exact barrier positioning, and easy anchor removal.
- The DANFORTH TYPE ANCHOR provides a positive gripping hold on most waterway bottoms. It has been factory drilled near the anchor hook pivot point, allowing the positioning/retrieval line and buoy to be attached in a way that assures easy dislodging and removal at the project's end.
- The Anchor Kit's three lines, four thimbles, seven shackles, and one anchor rode chain are all needed to achieve peak barrier performance and best anchor holding capabilities. All are factory assembled with professionally braided rope end loops.

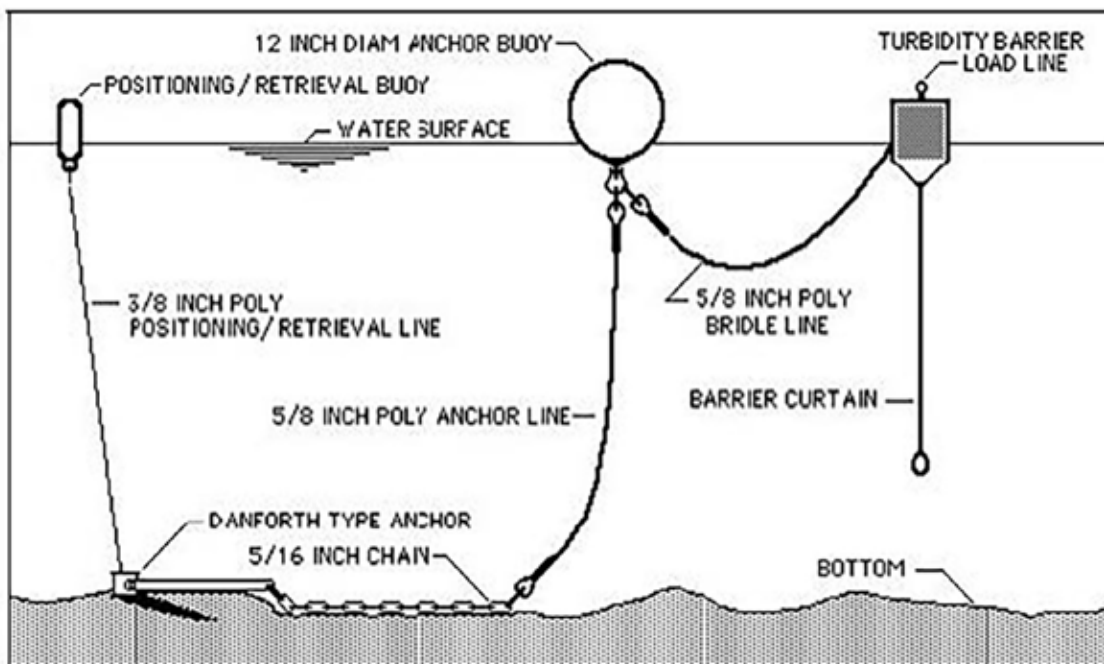

Figure 6. Turbidity Installation

To install an Anchor Kit on one side of Floating Turbidity Barrier, Type 2 or 3:

1. Attach the LOAD LINE to the cable loop at the end of the top tension cable of the barrier using the SHACKLE at the end of the load line.
2. Back the boat away from the barrier and drop the ANCHOR BUOY into the water.
3. Slowly back away from the barrier while paying out all the ANCHOR LINE, carefully lower the ANCHOR over the side, and lower the anchor with the POSITIONING/RETRIEVAL LINE until it settles onto the bottom.
4. Hold the POSITIONING/RETRIEVAL BUOY, slowly back away until the barrier is in the desired position, and drop the POSITIONING/RETRIEVAL BUOY into the water.

To remove an Anchor Kit:

1. Grab the POSITIONING/RETRIEVAL BUOY and lift the LINE until ANCHOR is dislodged from the bottom.
2. Retrieve the entire Anchor Kit and detach from the barrier.

5. DISCLAIMER

Disclaimer: Layfield disclaims any and all express, implied, or statutory standards, warranties or guarantees, including without limitation any implied warranty as to merchantability or fitness for a particular purpose or arising from a course of dealing or usage of trade as to any equipment, materials, or information furnished herewith. This document should not be construed as engineering advice.



About Layfield: The Layfield Group is the only integrated organization that provides tailored polymer-based solutions that are proven to protect our families, communities, and environment.

WWW.LAYFIELDGROUP.COM

Canada: 1.855.530.4226 | US: 1.855.894.7436



SCAN THE QR CODE TO
VIEW THE UP-TO-DATE
TECHNICAL SPECIFICATIONS